

Info card

Inductive Kplus sensors



i This info card serves as a supplement to the main position sensors catalogue and to the individual data sheets. For further information and contact addresses please visit our homepage at www.ifm.com

Intended use

While in use the products are exposed to influences which may have an effect on function, life, quality and reliability of the product.

It is the customer's responsibility to ensure that the products are suitable for the intended application. This applies in particular to applications in hazardous areas and with adverse environmental influence such as pressure, chemicals, temperature fluctuations, moisture and radiation as well as mechanical stress, especially if the products are not installed properly.

Using the products in applications where the safety of people depends on the function of the product is not permitted. Non-compliance may result in death or serious injuries.

Operating principle of an inductive Kplus sensor

Same sensing range on all metals (correction factor = 1). A transmitting and receiving coil system on a PCB constitutes a transformer. Electrically conductive materials in the near field affect the coupling factor of the transformer. The change of the coupling factor is converted into a switched output. By not using a ferrite core, the inductive Kplus sensors are less sensitive to interference caused by strong magnetic fields.

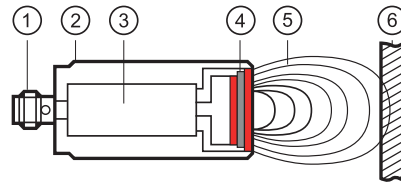

- ① Connection
- ② Housing
- ③ Evaluation circuit
- ④ PCB with transmitting and receiving coil
- ⑤ Alternating electromagnetic field = active zone
- ⑥ Target = electrically conductive material

Glossary of important terms

Active zone	Area above the sensing face in which the sensor reacts to the approach of the target.
Output function	Normally open: Object within the active zone > output switched. Normally closed: Object within the active zone > output blocked. Positive switching: positive output signal (to L-). Negative switching: negative output signal (to L+).
Rated insulation voltage	DC units with protection class II: 250 V DC units with protection class III: 60 V DC
Rated short-circuit current	For short-circuit-proof units: 100 A
Rated impulse withstand voltage	DC units with protection class II: 4 kV ($\hat{=}$ overvoltage category III) DC units with protection class III: 60 V DC: 0.8 kV ($\hat{=}$ overvoltage category II)
Power-on delay time	The time the sensor needs to be ready for operation after application of the operating voltage (in the millisecond range).
Operating voltage	The voltage range in which the sensor functions safely. A stabilised and smoothed direct voltage should be used! Take into account residual ripple!
Utilisation category	DC units: DC-13 (control of solenoids)

Hysteresis	Difference between the switch-on and the switch-off point.
Short-circuit protection	ifm sensors are protected against excessive current by means of a pulsed short-circuit protection. The inrush current of incandescent lamps, electronic relays and low resistance loads may cause this protection to cut in and turn the sensor off!
Storage temperature	-40°C...85°C acc. to EN 60068-2-1 Aa/2Ba: Duration of test 16 h each. Exception: For units specified with a lower or higher temperature, the data sheet value is taken as the guide value for the storage temperature.
Standard target	Square steel plate (e.g. S235JR) of a thickness of 1 mm with a side length (a) equal to the diameter of the sensing face or $3 \times S_n$, depending on which value is the highest.
Product standard	IEC 60947-5-2
Repeatability	Difference between any two S_r measurements. Max. 10 % of S_r .
Switch point drift	Shift in the switch point owing to changes in the ambient temperature.
Switching frequency	Damping with standard target (a x a) at half S_n . The ratio damped to undamped (mark to space) = 1 : 2.

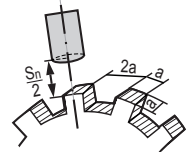

Protection	IPxy According to IEC 60529 IP68 Test condition: 1 m water depth for 7 days IP69k To ISO 20653 (replacement for DIN 40050-9)
SELV	Safety Extra Low Voltage (complies with protection class III).
Current consumption	Current for the internal supply of 3-wire DC units.
Degree of soiling	Inductive proximity sensors are designed for degree of soiling 3.

Info card

Inductive Kplus sensors



Sensing range (referred to the standard target)

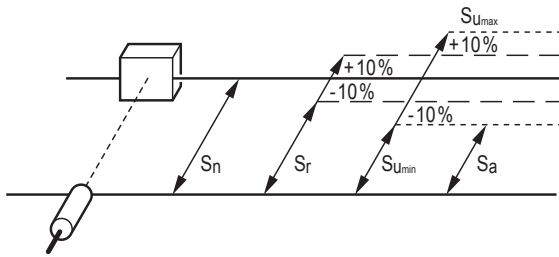

- Nominal sensing range S_n = characteristic value of the unit
- Real sensing range S_r = individual deviation at room temperature between 90 % and 110 % of S_n
- Useful sensing range S_u = switch point drift between 90 % ($S_{Umin} = S_a$) and 110 % (S_{Umax}) of S_r
- Assured sensing range = operating distance S_a = reliably switched between 0 % and 81 % of S_n
- Safe switch-off distance = $S_{Umax} + \text{max. hysteresis} = 143 \% \text{ of } S_n$

Influence of the target size

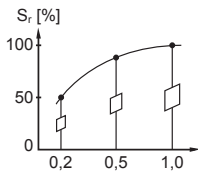

x axis: ratio actual target / standard target

Recommended detection conditions

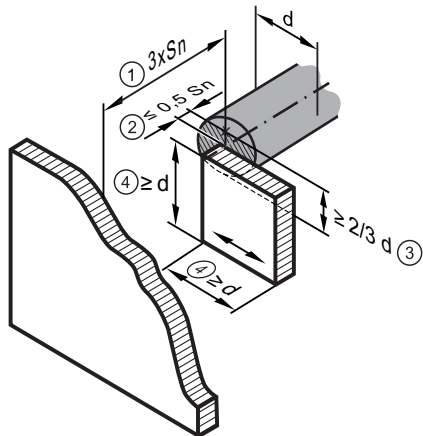

- ① Distance to the background
- ② Recommended target distance
- ③ Recommended degree of coverage of the sensing face
- ④ Recommended target size

Tips on flush and non-flush mounting in metal

Installation instructions cylindrical designs

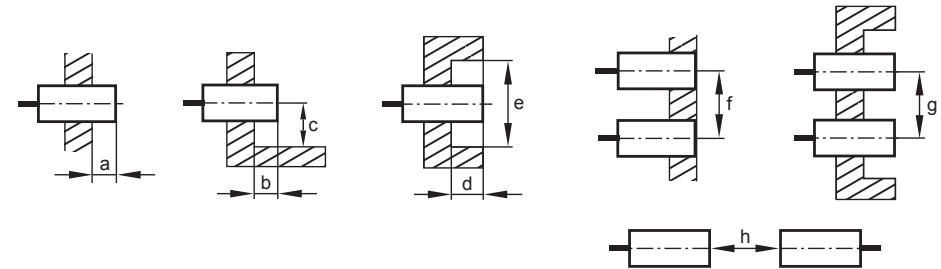

		S_n	a	b	c	d	e	f	g	h
M8	b	1,5	-	-	7	-	-	16		8x S_n
		3	-	-	7	-	-	16		
	nb	4	8	8	12	8	32	-	32	
		6	8	12	12	12	32	-	32	
M12	b	3	-	-	8	-	-	24	-	
		4	-	-	8	-	-	24	-	
	nb	8	10	10	18	16	36	-	48	
		10	12	20	18	20	48	-	48	
M18	b	5	-	-	11	-	-	36	-	
		8	-	-	11	-	-	36	-	
	nb	12	15	15	27	24	54	-	72	
		15	18	30	27	30	72	-	72	
M30	b	10	-	-	17	-	-	60	-	
		15	-	-	17	-	-	60	-	
	nb	22	22,5	22,5	45	37	90	-	150	
		30	30	37	45	37	150	-	150	

i Installation instructions rectangular designs → see enclosed operating instructions or www.ifm.com

Info card

Inductive Kplus sensors



Electrical connection

- ① Negative switching
- ② Positive switching
- ③ Sensor 1
- ④ Sensor n

Connection systems

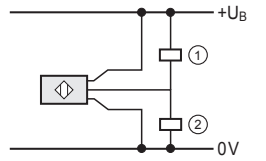

3-wire technology
(negative or positive switching)

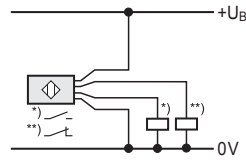

4-wire technology
(positive switching, normally closed and normally open)

Series connection (AND)

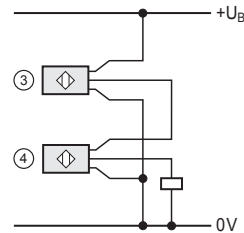

Parallel connection (OR)

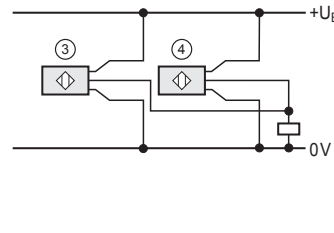

Series connection of 3-wire units

Max. 4 units. Power-on delay times, voltage drops and current consumption add up. $U_{B\ min}$ (sensor) and $U_{HIGH\ min}$ (load) must remain unchanged.

Parallel connection 3-wire units

The current consumption of all non-switched units adds up. The units can be used in combination with mechanical switches.

Configuration of cables and connectors

Colours: BK: black, BN: brown, BU: blue, WH: white

Standard configuration for 3-wire DC:

		Cable	US-100 plug
L+		BN	Pin 1 / BN
L-		BU	Pin 3 / BU
Output		BK	Pin 2 / WH Pin 4 / BK

Pin configuration of the US-100 connectors (view onto the plug at the unit)

Pin 4: BK
Pin 1: BN

Pin 3: BU
Pin 2: WH

Please refer to the wiring diagrams in our main catalogue for position sensors for the cable and the pin configuration as well as the unit data of special versions.

Magnetic flux density depending on distance and current

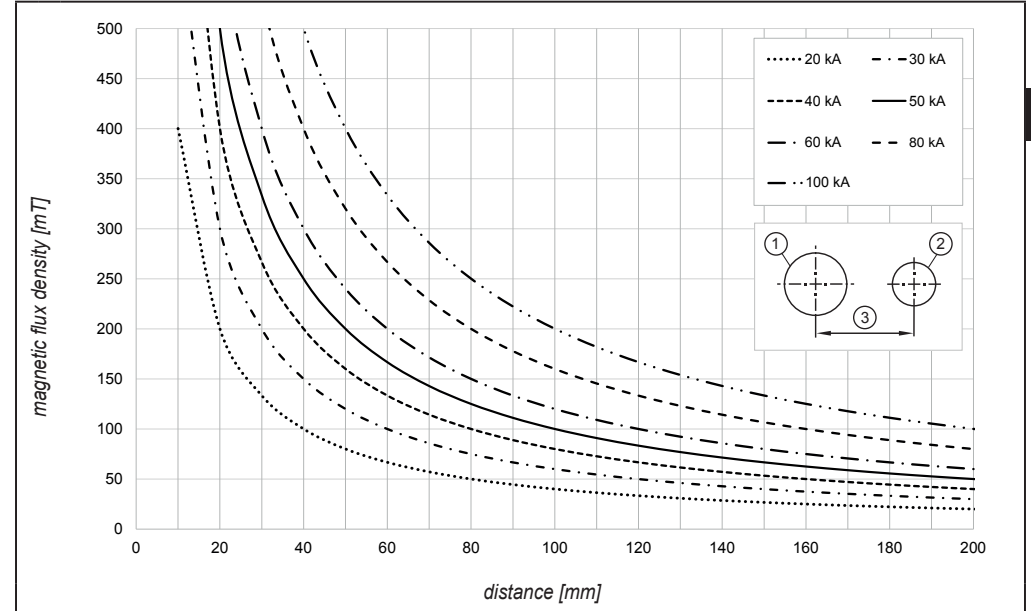

① live wire

② sensor

③ distance

UK